

**How to Draft a 10-Century Outfit**  
**Acacia de Navarre**

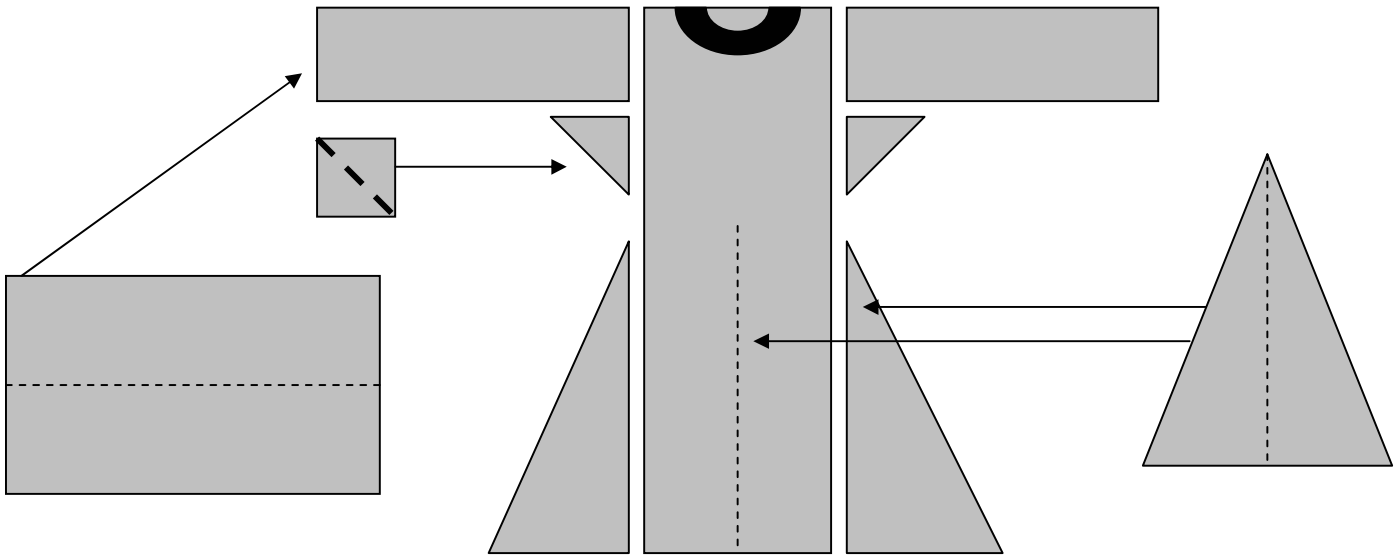

**Measurements you will need**

**Seam Allowance?** – What seam allowance will you use? \_\_\_\_\_

**Hem Allowance?** – What Hem Allowance will you use?  
(Always best to have a bit extra) \_\_\_\_\_

**Length** – Measure from where your neck joins your shoulder to the length \_\_\_\_\_

**Width** – Measure your ribcage (just under your bust – breath in)  
OK this is going to determine how fitting your outfit will be so if you don't want it skin tight then you will need to add an inch or 2 (or more)  
\_\_\_\_\_

**Arm Length** – measure from your shoulder point to the wrist (or wherever you want the sleeve to end)  
\_\_\_\_\_

**Arm Drop** – measure from your shoulder point to the depth you want your sleeve  
\_\_\_\_\_

**Gore Drop** – put your hands on your waist. Now measure from that point to the length of the outfit  
\_\_\_\_\_

**Underarm Gore** – put your two pointer fingers together at the tip and make a square with your thumbs, measure one side of the square  
\_\_\_\_\_

**Neck** – measure loosely around your neck (don't want to strangle yourself)

---

**To make the Body – (you will need 2 of these)**

**A** =  $\frac{1}{2}$  Width Measurement + 2 x Seam Allowance \_\_\_\_\_

**B** = Length + Seam Allowance + Hem Allowance \_\_\_\_\_

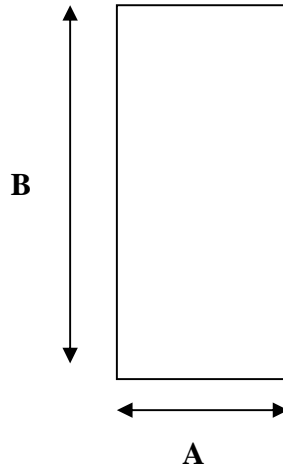

**To make the Arm (you will need two of these)**

**C** = Arm Length + 2 x Seam Allowance \_\_\_\_\_

**D** = 2 x Arm Drop + 2 x Seam Allowance \_\_\_\_\_

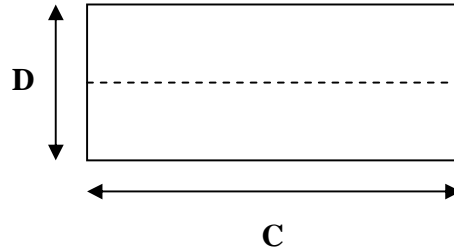

**To Make the Underarm Gore**

**F** = Underarm Gore Measurement + 2 x Seam Allowance

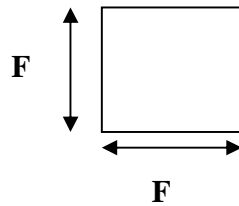

### To Make Side and Centre Front/Back Gores

**G** = Length of Gore + Seam Allowance + Hem Allowance \_\_\_\_\_

You will need 4 Gores each the same size (unless you are making male garb with a horse cut at the centre front and back in which case you will only need 2). The base measurement of the gores will determine how swirly the hem of your dress will be.

To be really economical on fabric the size of these gores is best determined by the size of your fabric and the layout.

When you layout your fabric with the pattern pieces always start with the biggest pieces first and then work down.

For Example (these are guilds only) - The left over Grey areas are what we are going to use for the gores.

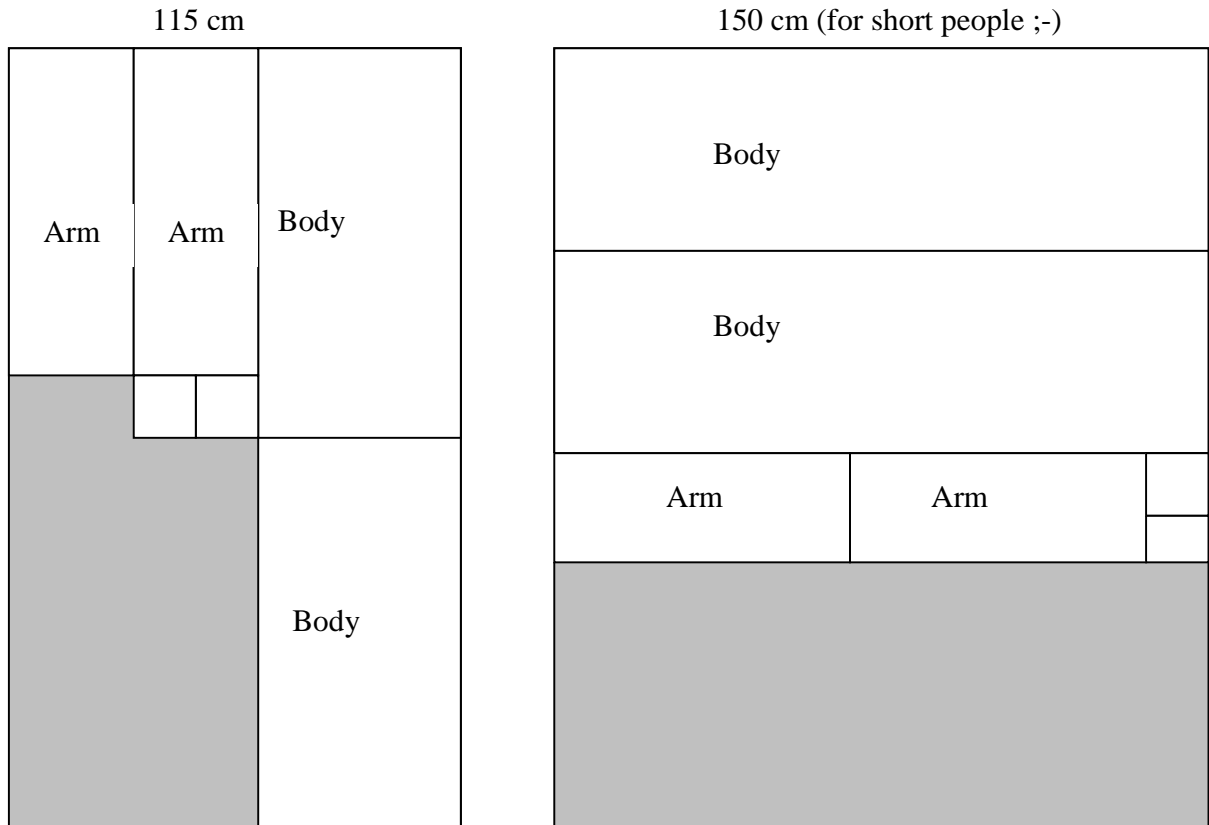

In the remaining fabric measure off the length of the gore (**G**) in the grey area (see below)

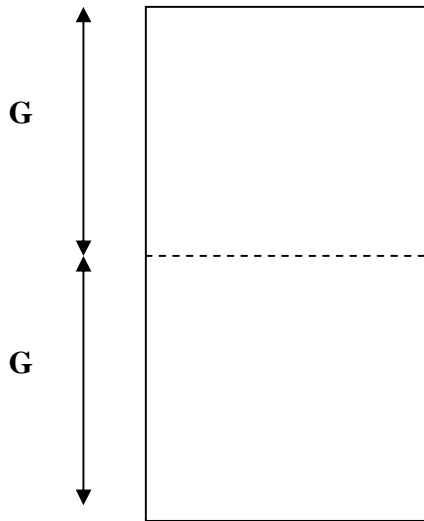

Now you have the length of your gores marked out, we need to divide the area into 4 rectangles.

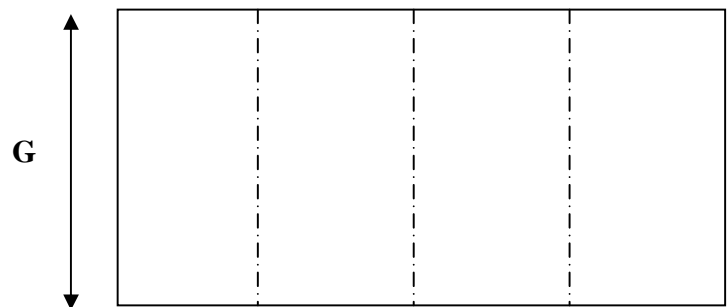
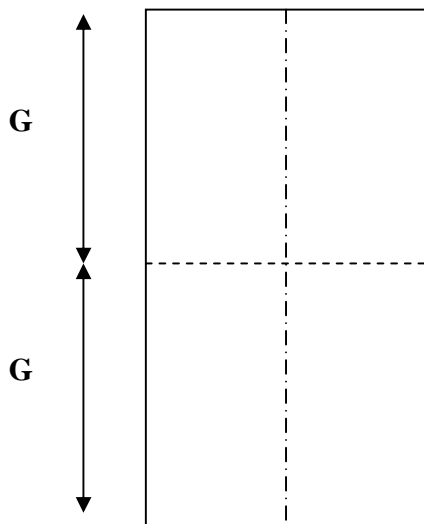

To make the gores we are now going to make right angle triangles out of the rectangles and then sew them back together to make an equilateral triangle so that we will have equal inserts for the sides and centre front and back.

This will give us the maximum base measurement out of the remaining fabric. (It is good to have the centre front gore and the centre back gore as a full triangles but this is not essential)

See below for a guide to do this

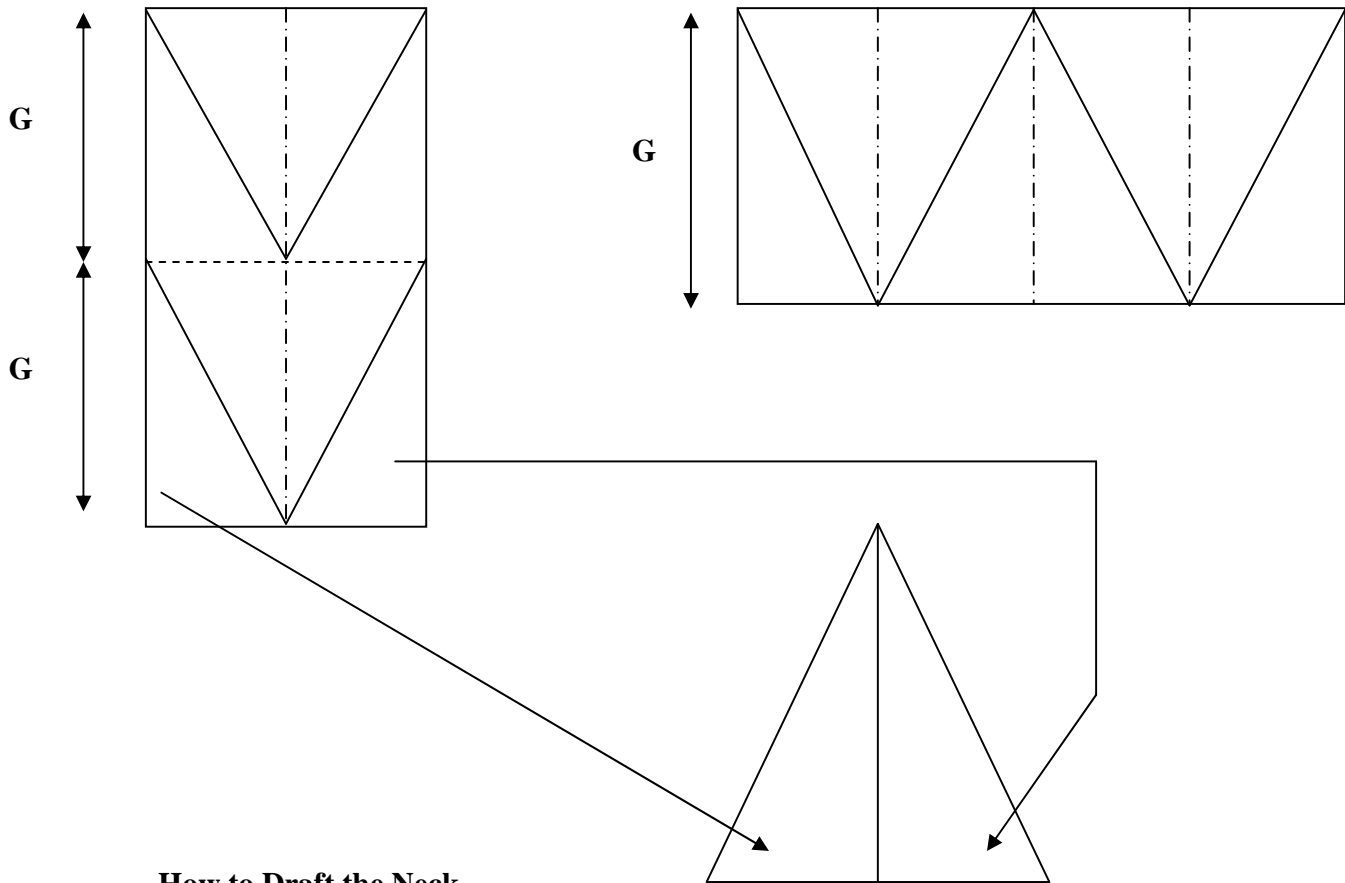

### How to Draft the Neck

1. First decide on what type of neck line you want?
2. Sew the two Dress bodies together at the top. Lay out your two bodies flat and mark out the centre line (parallel to the sides).
3. Take some paper and make an oval from the neck measurement and cut this out, will be your neck pattern. Fold your pattern in half (along the shallow side), so you have a centre measurement and mark it on the paper.
4. Your neck is on the front of your body so you will need to position your pattern piece so that 2/3's are on the front and 1/3 is to the back. Line up the centre marks and mark your neck out. It is best to make up your whole outfit before cutting out the neck.

